

Soluzione geniale IDEATA e progettata da Olimpia, il sistema gocciolatoio per finestre in legno "SIRIO" possiede le vantaggiose caratteristiche rispetto a gocciolatoi esistenti.

- 1) Alluminio esterno al legno, curva termica spostata verso esterno.
- 2) Eliminazione del terminale di controsagoma.
- 3) Eliminazione della siliconatura sul terminale.
- 4) Nessuna cava di alloggiamento sul legno.
- 5) Aggancio con funzione di taglio termico.
- 6) Ampia camera di scarico acqua.
- 7) Bloccaggio mediante aggancio con eliminazione di viti a vista esterna.
- 8) Possibilità di montare guarnizione esterna su gocciolatoio.
- 9) Scarichi acqua non a vista.
- 10) Linee tondeggianti.
- 11) Aerazione tra alluminio e legno

Das Tropfrinnsystem für Holzfenster "SIRIO" ist eine von Olimpia entwickelte und ausgearbeitete geniale Lösung und weist gegenüber den vorhandenen Tropfrinnen vorteilhafte Eigenschaften auf.

- 1) Aluminium auf der Außenseite des Holzes, nach außen verschobene Wärmekurve.
- 2) Beseitigung des Abschluss der Gegenform.
- 3) Beseitigung der Silikonisierung am Abschluss.
- 4) Keine Aufnahmekehle im Holz.
- 5) Haken mit Wärmesperrenfunktion.
- 6) Große Wasserauslasskammer.
- 7) Blockierung mit Haken und Beseitigung von sichtbaren externen Schrauben.
- 8) Möglichkeit der Montage von Dichtungen auf der Außenseite der Tropfrinne.
- 9) Unsichtbarer Wasserauslass.
- 10) Rundliche Linien.
- 11) Lüftung zwischen Aluminium und Holz

Solution géniale inventée et conçue par Olimpia, le système d'égouttoir pour les fenêtres en bois « SIRIO » offre des caractéristiques avantageuses par rapport aux égouttoirs actuellement disponibles sur le marché.

- 1) Aluminium à l'extérieur du bois, courbe thermique déplacée à l'extérieur.
- 2) Élimination de l'élément terminal du contre-cadre.
- 3) Élimination de l'application de la silicone sur l'élément terminal.
- 4) Aucune rainure de logement sur le bois.
- 5) Accrochage avec fonction de coupe thermique.
- 6) Vaste chambre d'évacuation de l'eau.
- 7) Blocage par accrochage avec l'élimination de vis visibles à l'extérieur.
- 8) Possibilité d'installer le joint extérieur sur l'égouttoir.
- 9) Évacuations de l'eau non visibles.
- 10) Lignes arrondies.
- 11) Aération entre l'aluminium et le bois.

Solución genial ideada y proyectada por Olimpia, el sistema de goterón para ventanas de madera "SIRIO" posee características ventajosas respecto a goterones ya existentes.

- 1) Aluminio exterior a la madera, curva térmica desplazadas hacia afuera.
- 2) Eliminación del terminal de contraperfil.
- 3) Eliminación del siliconado en el terminal.
- 4) Ninguna ranura de alojamiento en la madera.
- 5) Enganche con función de corte térmico.
- 6) Amplia cámara de descarga de agua.
- 7) Bloqueo mediante enganche sin tornillos visibles.
- 8) Posibilidad de montar junta de goma externa en el goterón.
- 9) Descargas de agua no visibles.
- 10) Líneas redondeadas.
- 11) Espacio entre aluminio y madera.

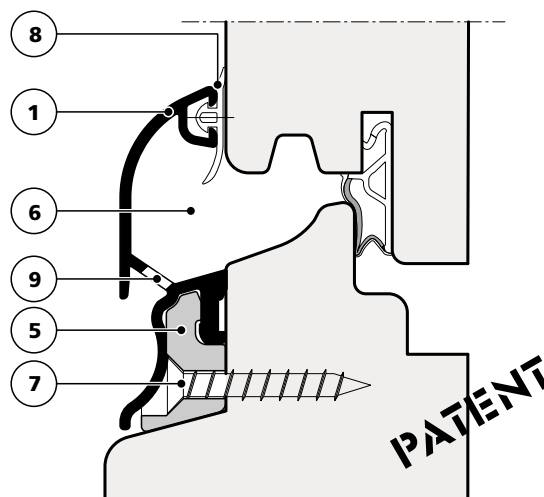

**GUARNIZIONI SISTEMA**

DICHTUNGEN SYSTEM / JOINTS DE SYSTÈME / JUNTAS DE GOMA SISTEMA

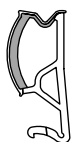

Cod.	Serie	Materiale
<b>15000798</b>	AZZURRA	TPE-S
<b>15000708</b>	ORO	EPDM
<b>1600496</b>	META	EPDM
<b>1500528</b>	10	TPE

**GUARNIZIONI PER PROFILI**

DICHTUNGEN FÜR PROFILE / JOINTS POUR PROFILS / JUNTAS DE GOMA PARA PERFILES



Cod.
<b>15000754</b>

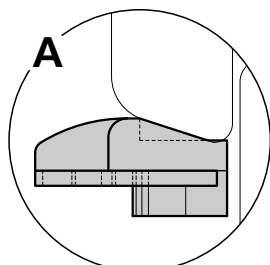

**A**  
**TERMINALE**  
 ABSCHLUSS  
 ÉLÉMENT TERMINAL  
 TERMINAL  
 cod. **43703076**

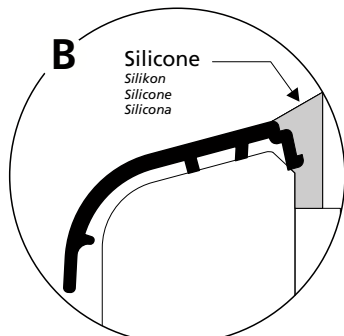

**B**  
 Variante applicazione profilo  
 cod. **39003200** senza aggancio

Variante Profilanbringung  
 Cod. **39003200** ohne Haken  
 Option d'application de profil  
 cod. **39003200** sans accrochage  
 Variante aplicación perfil  
 cod. **39003200** sin enganche

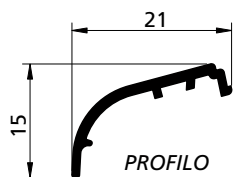

**PROFILO**  
 PROFIL  
 PROFIL  
 PERFIL  
 cod. **39003200**

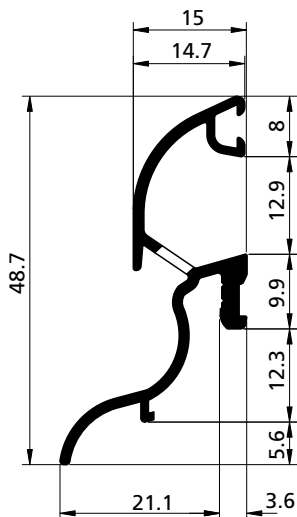

**PROFILO**  
 PROFIL  
 PROFIL  
 PERFIL  
 cod. **39003070**

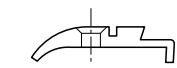

**AGGANCIO**  
 HAKEN / ACCROCHAGE / ENGANCHE  
 cod. **43503207**

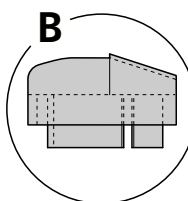

**B**  
**TERMINALE**  
 ABSCHLUSS  
 ÉLÉMENT TERMINAL  
 TERMINAL  
 cod. **43703206**

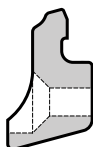

**AGGANCIO**  
 HAKEN  
 ACCROCHAGE  
 ENGANCHE  
 cod. **42702881**

**VITE CONSIGLIATA**  
 SCHRAUBE BERATEN  
 VIS COINSELLÉ  
 TORNILLO ACOSEIDA  
 3,5 x 25

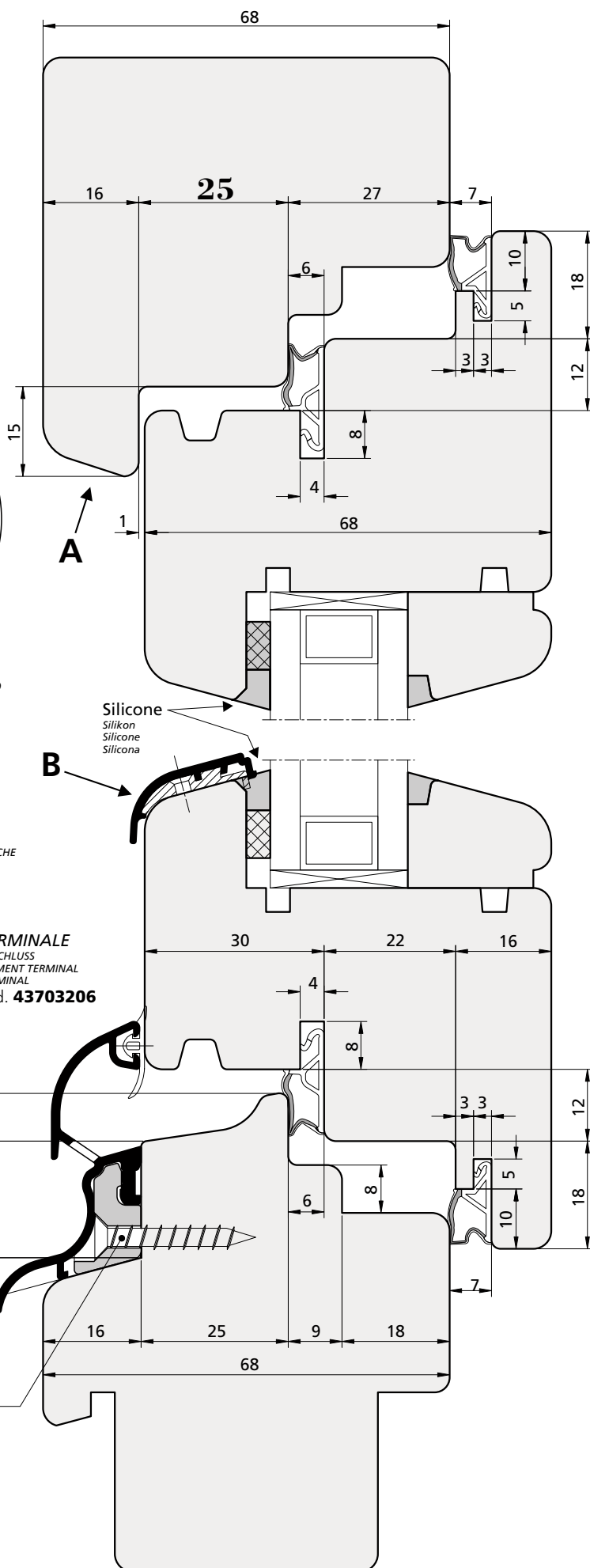

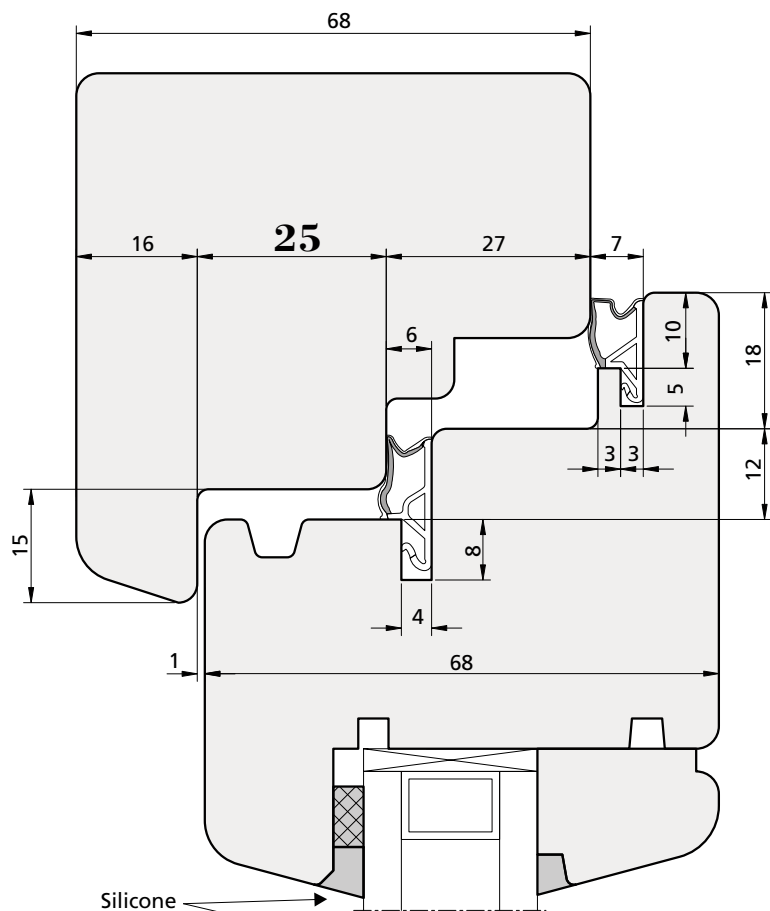

Silicone  
 Silikon  
 Silicone  
 Silicona

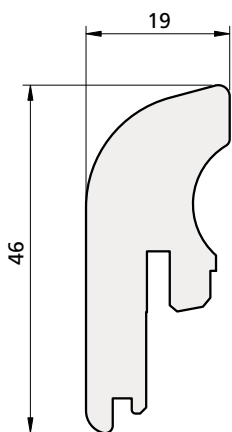
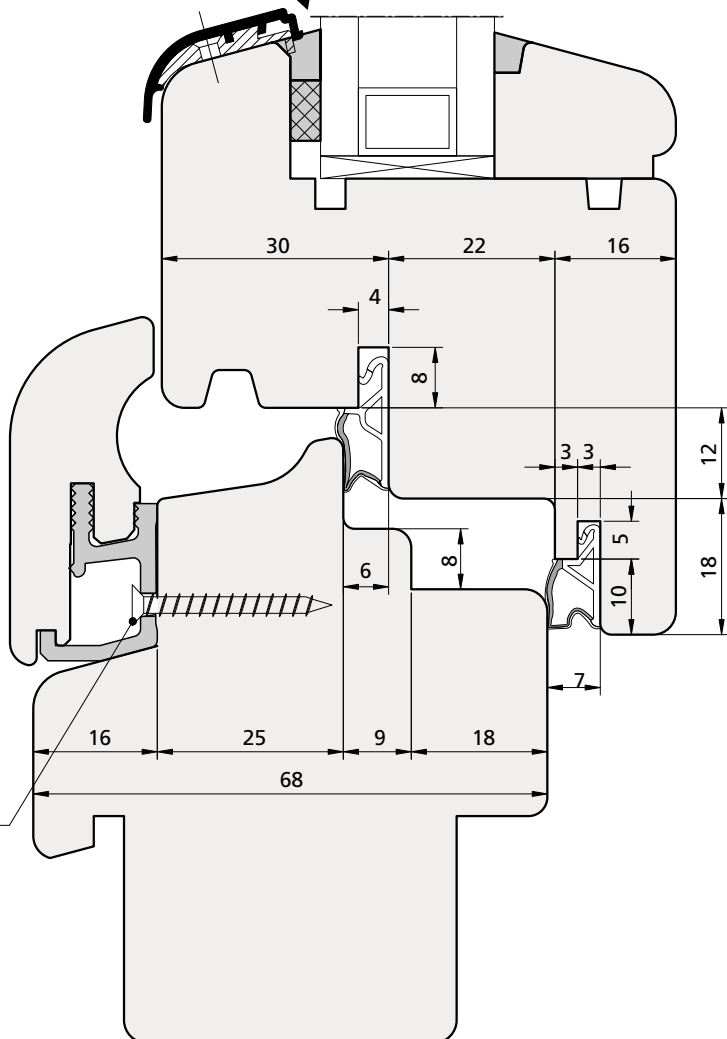

**FASCETTA IN LEGNO**  
 HOLZSTREIFEN  
 LISSE EN BOIS  
 ABRAZADERA DE MADERA

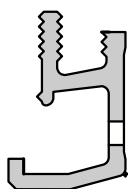

**AGGANCI**  
 HAKEN  
 ACCROCHAGE  
 ENGANCHE  
 cod. **42702882**

**VITE CONSIGLIATA**  
 SCHRAUBE BERATEN  
 VIS COINSELLÉ  
 TORNILLO ACOSEIDA  
 3,5 x 25

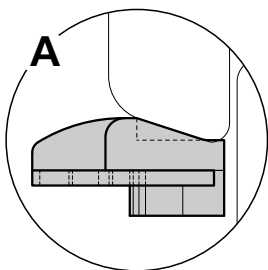

**A**  
**TERMINALE**  
 ABSCHLUSS  
 ÉLÉMENT TERMINAL  
 TERMINAL  
 cod. **43703076**

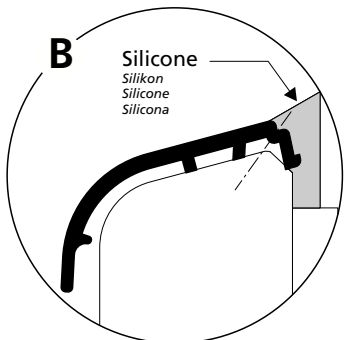

**B** Silicone  
 Silikon  
 Silicone  
 Silicona  
 Variante applicazione profilo cod. **39003200** senza aggancio  
 Variante Profilanbringung Cod. **39003200** ohne Haken  
 Option d'application de profil cod. **39003200** sans accrochage  
 Variante aplicación perfil cód. **39003200** sin enganche

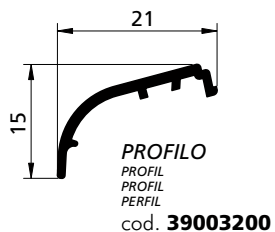

**PROFILO**  
 PROFIL  
 PROFIL  
 PERFIL  
 cod. **39003200**

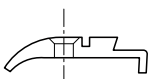

**AGGANCI**  
 HAKEN / ACCROCHAGE / ENGANCHE  
 cod. **43503207**

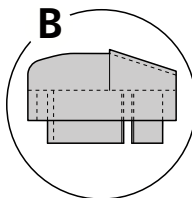

**B**  
**TERMINALE**  
 ABSCHLUSS  
 ÉLÉMENT TERMINAL  
 TERMINAL  
 cod. **43703206**

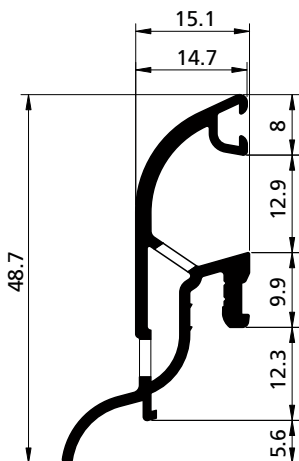

**PROFILO**  
 PROFIL  
 PROFIL  
 PERFIL  
 cod. **39003190**

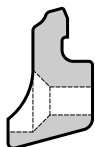

**AGGANCI**  
 HAKEN  
 ACCROCHAGE  
 ENGANCHE  
 cod. **42702881**

**VITE CONSIGLIATA**  
 SCHRAUBE BERATEN  
 VIS COINSELLÉ  
 TORNILLO ACOSEIDA  
 3,5 x 25

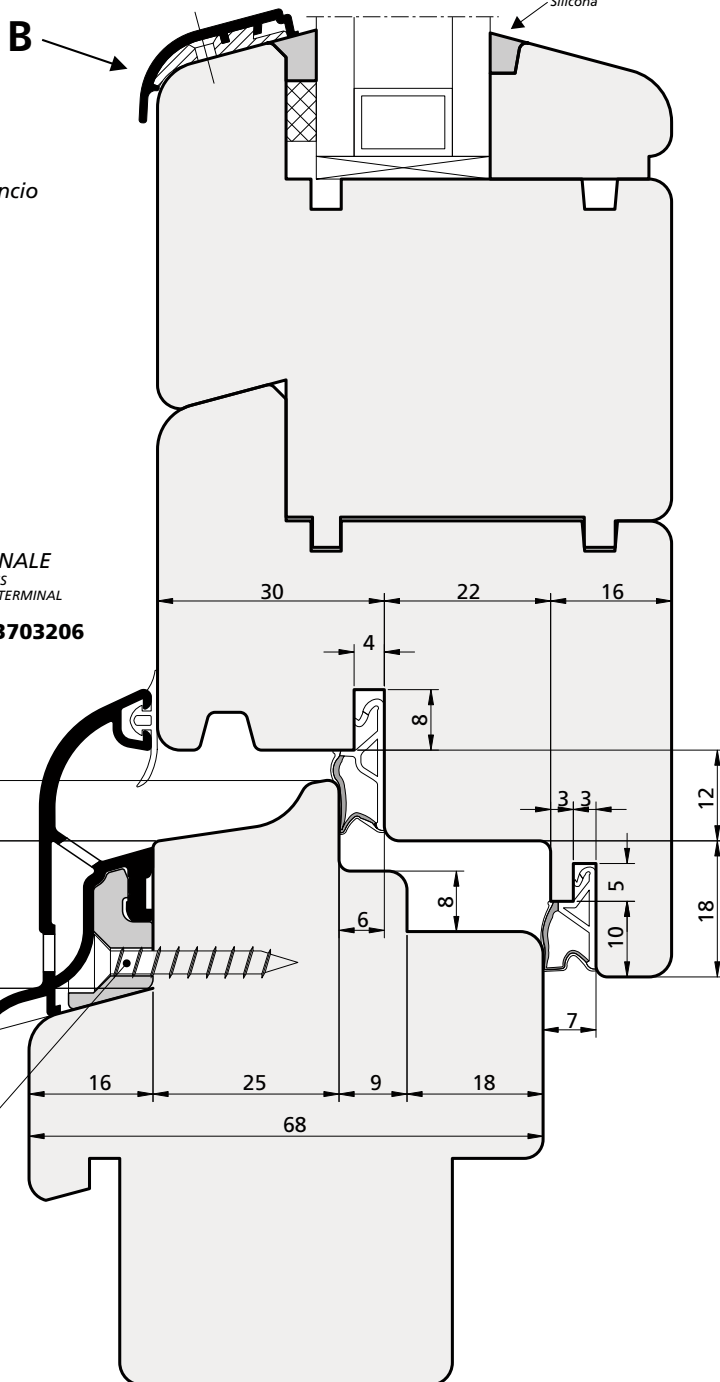
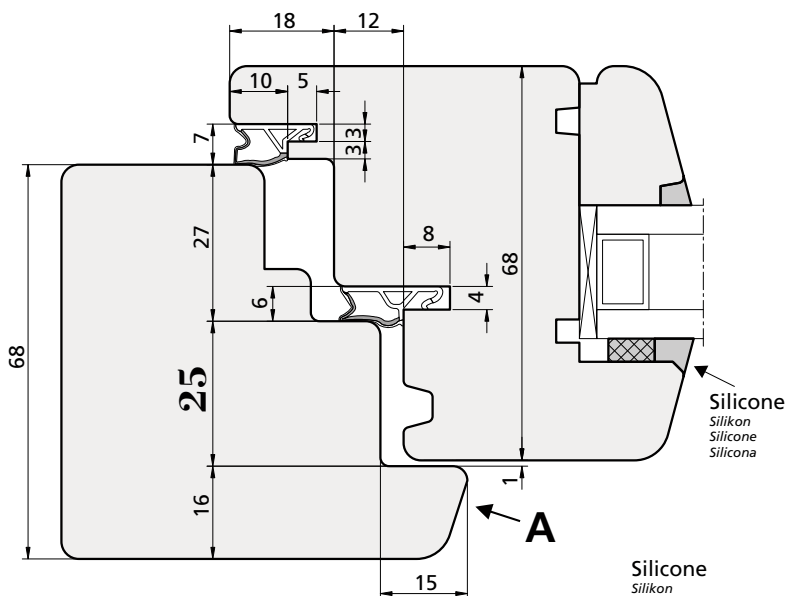

**GUARNIZIONI SISTEMA**

DICHTUNGEN SYSTEM / JOINTS DE SYSTÈME / JUNTAS DE GOMA SISTEMA



Cod.	Serie	Materiale
<b>15000798</b>	AZZURRA	TPE-S
<b>15000708</b>	ORO	EPDM
<b>1600496</b>	META	EPDM
<b>1500528</b>	10	TPE

**GUARNIZIONI PER PROFILI**

DICHTUNGEN FÜR PROFILE / JOINTS POUR PROFILS / JUNTAS DE GOMA PARA PERFILES



Cod.  
**15000754**

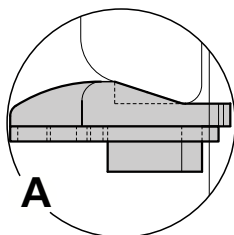

**TERMINALE**  
 ABSCHLUSS  
 ÉLÉMENT TERMINAL  
 TERMINAL  
 cod. **43703076**

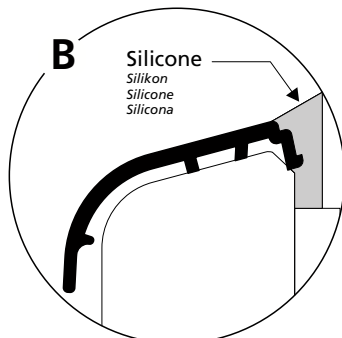

**Variante applicazione profilo**  
 cod. **39003200** senza aggancio

Variante Profilanbringung Cod. **39003200** ohne Haken  
 Option d'application de profil cod. **39003200** sans accrochage  
 Variante aplicación perfil cod. **39003200** sin enganche

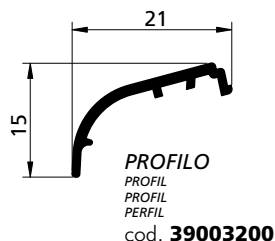

**PROFILO**  
 PROFIL  
 PROFIL  
 PERFIL  
 cod. **39003200**

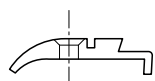

**AGGANCIO**  
 HAKEN / ACCROCHAGE / ENGANCHE  
 cod. **43503207**

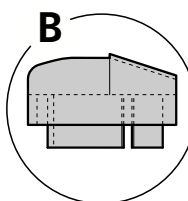

**TERMINALE**  
 ABSCHLUSS  
 ÉLÉMENT TERMINAL  
 TERMINAL  
 cod. **43703206**

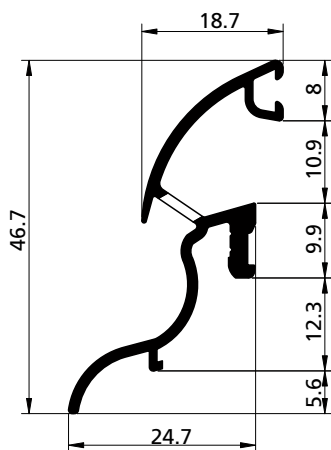

**PROFILO**  
 PROFIL  
 PROFIL  
 PERFIL  
 cod. **39003210**

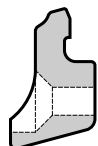

**AGGANCIO**  
 HAKEN  
 ACCROCHAGE  
 ENGANCHE  
 cod. **42702881**

**VITE CONSIGLIATA**  
 SCHRAUBE BERATEN  
 VIS COINSELLE  
 TORNILLO ACOSEIDA  
 3,5 x 25

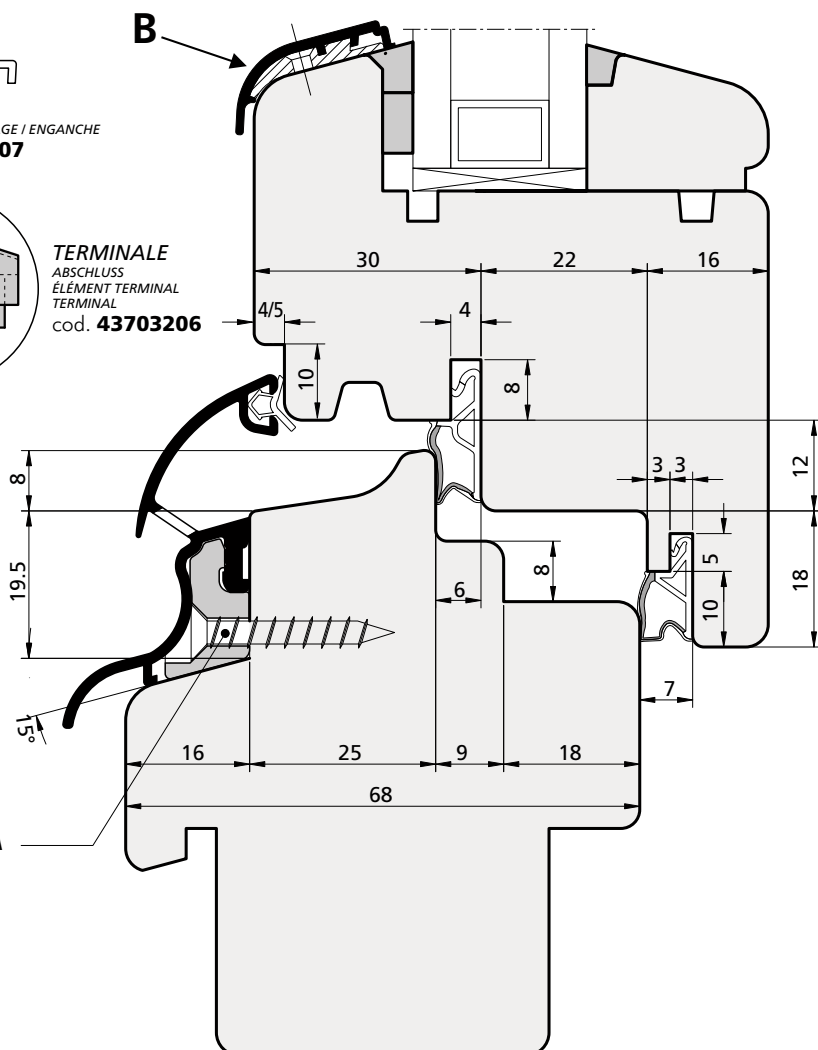

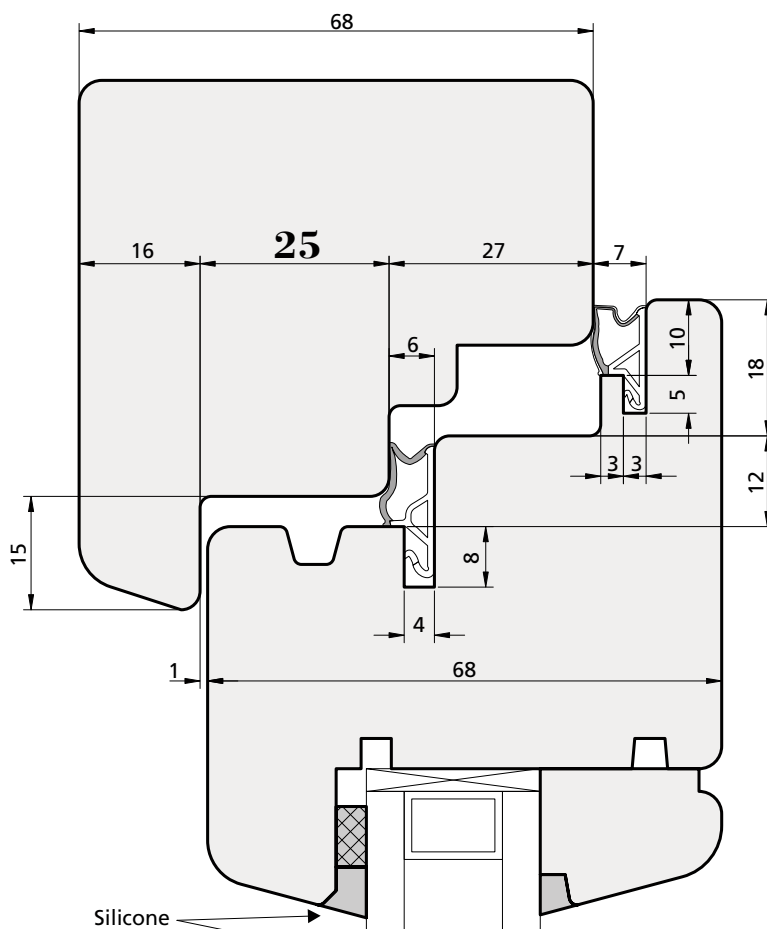

Silicone  
 Silikon  
 Silicone  
 Silicona

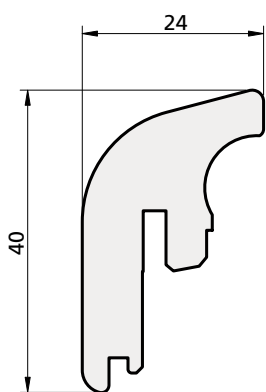
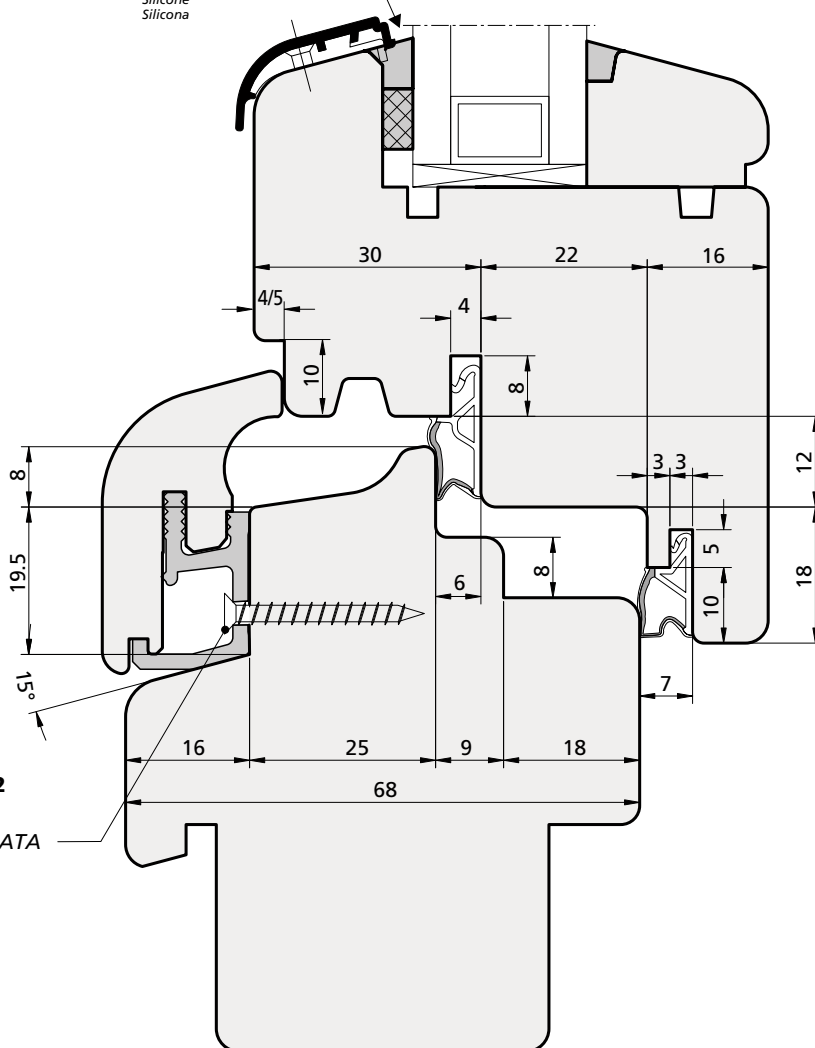

**FASCETTA IN LEGNO**  
 HOLZSTREIFEN  
 LISSE EN BOIS  
 ABRAZADERA DE MADERA

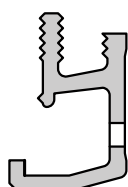

**AGGANCIO**  
 HAKEN  
 ACCROCHAGE  
 ENGANCHE  
 cod. **42702882**

**VITE CONSIGLIATA**  
 SCHRAUBE BERATEN  
 VIS COINSELLÉ  
 TORNILLO ACONSEJADA  
 3,5 x 25

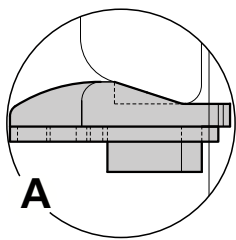

**A**

**TERMINALE**  
 ABSCHLUSS  
 ÉLÉMENT TERMINAL  
 TERMINAL  
 cod. **43703076**

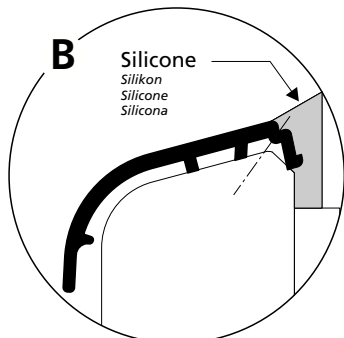

**B**

Silicone  
 Silikon  
 Silicone  
 Silicona

*Variante applicazione profilo  
 cod. **39003200** senza aggancio*  
 Variante Profilanbringung Cod. **39003200** ohne Haken  
 Option d'application de profil cod. **39003200** sans accrochage  
 Variante aplicación perfil cód. **39003200** sin enganche

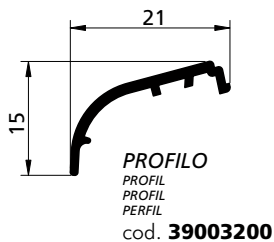

**PROFILO**  
 PROFIL  
 PROFIL  
 PERFIL  
 cod. **39003200**

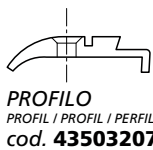

**PROFILO**  
 PROFIL / PROFIL / PERFIL  
 cod. **43503207**

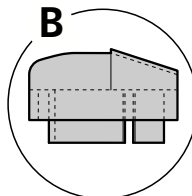

**B**

**PROFILO**  
 PROFIL  
 PROFIL  
 PERFIL  
 cod. **43703206**

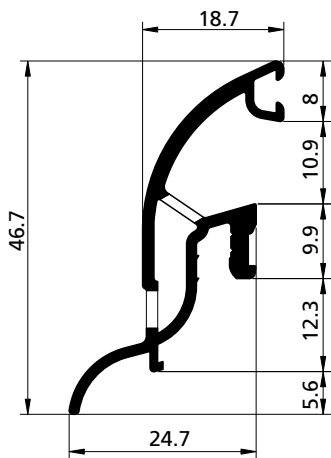

**PROFILO**  
 PROFIL  
 PROFIL  
 PERFIL  
 cod. **39003220**

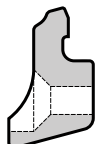

**VITE CONSIGLIATA**  
 SCHRAUBE BERATEN  
 VIS COINSELLÉ  
 TORNILLO ACOSEIDA  
 cod. **42702881**

**VITE CONSIGLIATA**  
 SCHRAUBE BERATEN  
 VIS COINSELLÉ  
 TORNILLO ACOSEIDA  
 3,5 x 25

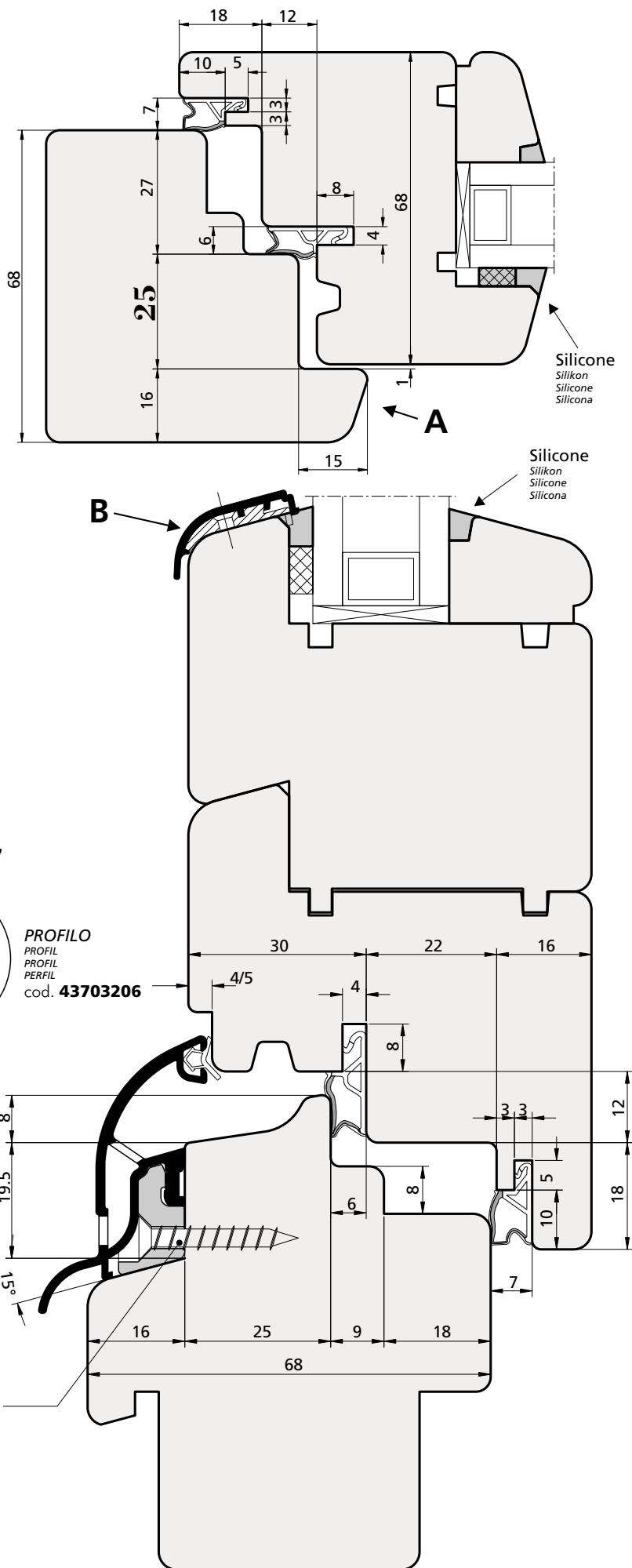

Silicone  
 Silikon  
 Silicone  
 Silicona

Silicone  
 Silikon  
 Silicone  
 Silicona

## 1° FASE

1. PHASE / 1<sup>ère</sup> PHASE / 1° FASE

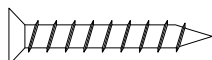

**VITE CONSIGLIATA**  
SCHRAUBE BERATEN  
VIS COINSELLÉ  
TORNILLO ACOSEIDA  
3,5 x 30

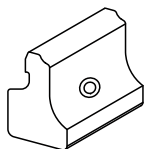

**AGGANCI**  
HAKEN  
ACCROCHAGE  
ENGANCHE  
cod. 42702881

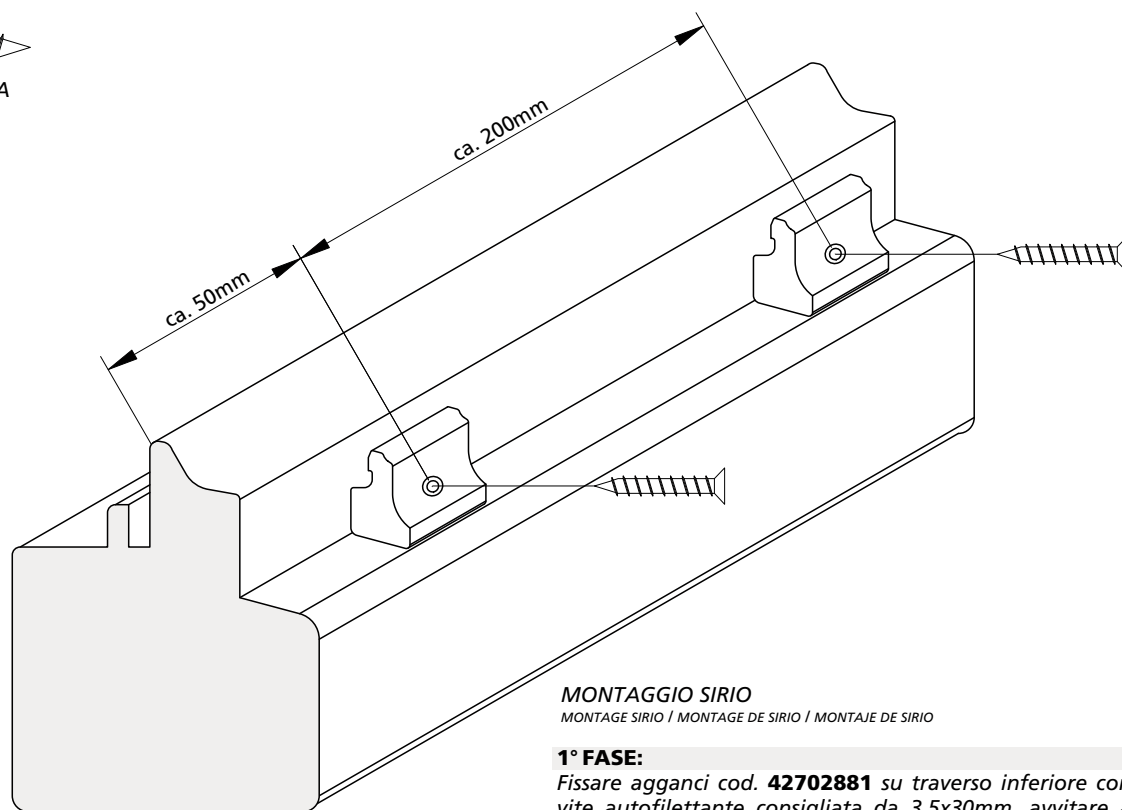

### MONTAGGIO SIRIO

MONTAGE SIRIO / MONTAGE DE SIRIO / MONTAJE DE SIRIO

#### 1° FASE:

Fissare agganci cod. 42702881 su traverso inferiore con vite autofilettante consigliata da 3,5x30mm. avvitarle a 50mm i primi due agganci all'estremità, mantenere circa 200mm di interasse gli intermedi.

#### 1. PHASE:

Befestigen Sie den Haken Cod. 42702881 mit selbst schneidenden Schrauben zu 3,5x30mm an der unteren Querstrebe. Schrauben Sie die beiden äußeren Haken in einem Abstand von ca. 50 mm an und halten Sie einen Abstand von ca. 200 mm bei den mittleren Haken.

#### 1<sup>ère</sup> PHASE:

Fixer les accrochages code 42702881 à la traverse basse à l'aide d'une vis auto-taraudeuse conseillée de 3,5x30mm. Visser à environ 50mm les deux premiers accrochages à l'extrémité et garder environ 200mm d'entraxe entre les éléments intermédiaires.

#### 1° FASE:

Fijar los enganches código 42702881 en la traviesa inferior con tornillo autorroscante aconsejado de 3,5x30mm, enroscar a unos 50 mm los primeros dos enganches al extremo, mantener los intermedios a unos 200 mm de distancia.

## 2° FASE

2. PHASE / 2<sup>ème</sup> PHASE / 2° FASE

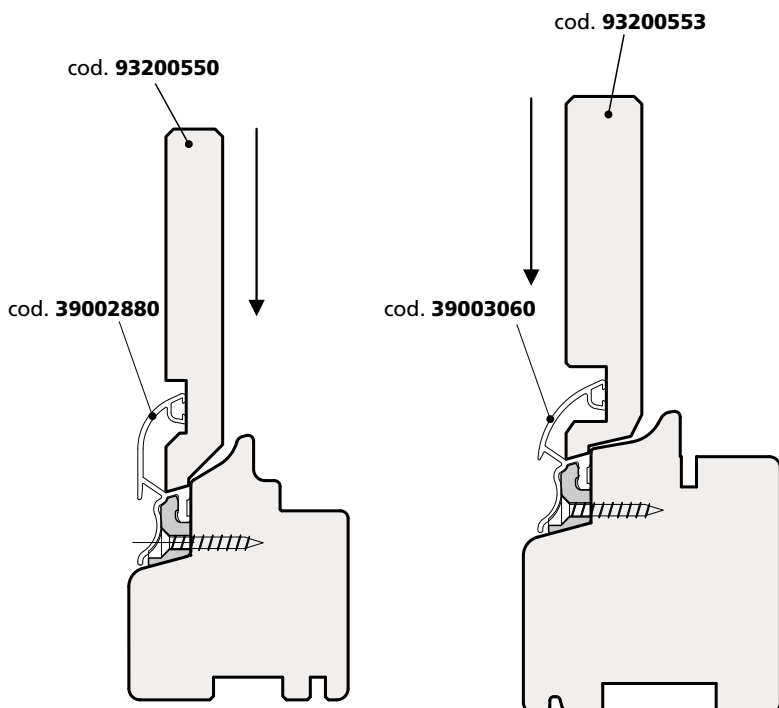

#### 2° FASE:

Utilizzare apposite dime cod. 93200550 o 93200553 controsagomate ai profili per fissare gli agganci cod. 42702881 al traverso inferiore.

#### 2. PHASE:

Verwenden Sie die entsprechenden Schablonen Cod. 93200550 oder 93200553 gegengeformte am den Profile mit den Haken Cod. 42702881 an der unteren Querstrebe.

#### 2<sup>ème</sup> PHASE:

Utiliser les gabarits ad hoc code 93200550 ou 93200553 contre-galbés sur les profils pour fixer les accrochages code 42702881 à la traverse basse.

#### 2° FASE:

Utilizzare apposite dime cod. 93200550 o 93200553 controsagomate ai profili per fissare gli agganci cod. 42702881 al traverso inferiore.